





INSTALLATION HANDBOOK CONCRETE ANCHORS

SafetyLink is an innovative anchor company achieving success and keeping you safe whilst working at heights.

-  ROOF ANCHORS
-  HORIZONTAL LIFELINES
-  PERMANENT LADDERS
-  LADDER STABILISERS
-  TEMPORARY ANCHOR



Read entire handbook before installing SafetyLink products. All products must be installed in accordance with SafetyLink's installation handbook, using only products supplied by SafetyLink Pty Ltd. Failure to follow all warnings and instructions may result in serious injury or death.



SafetyLink Pty Ltd
AU: 1300 789 545
INT: +61 2 4964 1068
info@safetylink.com

www.safetylink.com

TABLE OF CONTENTS

INSTALLATION OF SAFETYLINK CONCRETE ANCHORS

WARNINGS.....	3
MAINTENANCE – PERIODIC INSPECTIONS.....	4
WARRANTIES	5
CONCRETELINK ANCHOR POINT.....	6
CONCRETELINK COLLARED EYEBOLT ANCHOR.....	7
CONCRETELINK ONE PIECE EYEBOLT ANCHOR.....	8
WINDOWLINK ANCHOR POINT.....	9
SWIVELINK ANCHOR POINT.....	10
SPACERLINK ANCHOR POINT.....	11
APPENDIX 1 – CONCRETE INJECTION MORTAR.....	12
APPENDIX – DIAGRAM 2 – ANCHOR POSITIONING LAYOUT.....	13
EXPERT FALL PROTECTION PLANNING	14
NOTES	15
IN CASE OF ACCIDENT.....	16



Safety Centre
Training



Installation Video



Anchor Layout
Video



Catalogue



Website



WARNINGS



READ CAREFULLY SOMEONE'S LIFE DEPENDS ON IT

INSTALLATION MUST BE CARRIED OUT BY, OR UNDER THE SUPERVISION OF A COMPETENT HEIGHT SAFETY INSTALLER. The building or structure for the anchorages should be assessed by an engineer, unless it is clear to a competent height safety installer that the anchorages system is structurally adequate.

- STANDARD EYEBOLTS MUST ONLY BE USED AS A FALL ARREST ANCHOR.**
- ABSEILING EYEBOLTS ARE TO BE USED FOR ROPE ACCESS (ABSEILING).**
- SURFACE MOUNTED ANCHORS MUST NOT BE USED FOR ROPE ACCESS (ABSEILING).**
- RETRO EYEBOLTS USED FOR ROPE ACCESS (ABSEILING) EXCEPT ON HIGH PROFILE SECTION.**

When installing anchor points all safety procedures must comply in accordance with the current safety code/s of practice/s for working at heights.

- Recommended waterproofing for roof tiles: *Sika Flex Co-Polymer Sealant*.
- Recommended waterproofing for metal roof: *Silicone Sealant*.
- A personal energy absorber or a fall-arrest device with a personal energy absorber must be used to connect to all SafetyLink Anchorages and (or) Strops.

- ⚠ **MAXIMUM USER PER EYEBOLT IS ONE (1)**
- ⚠ **If any doubt exists with the strength of the structure or roof sheets an engineer should make the assessment.**
- ⚠ **Installation must be carried out by, or under the supervision of a competent height safety installer.**
- ⚠ **During installation you must be safe at all times.**

WARNING

Locking Hex Nut must be fully screwed up the thread of the eyebolt to expose 30mm of thread.

This thread must be fully screwed into the bracket.

Locking Hex Nut must be firmly tightened onto the bracket to stop the eyebolt from unscrewing and to gain maximum strength.

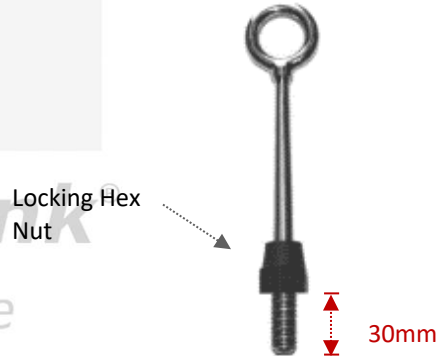

- EYEBOLTS - Threads need to have a minimum of SIX FULL 360° TURNS into the ultimate thread.**
- RETRO EYEBOLTS - Threads need to have a minimum of EIGHT FULL 360° TURNS into the ultimate thread.**



CORRECT

Always use a spanner when tightening and un-tightening the locking hex nut.

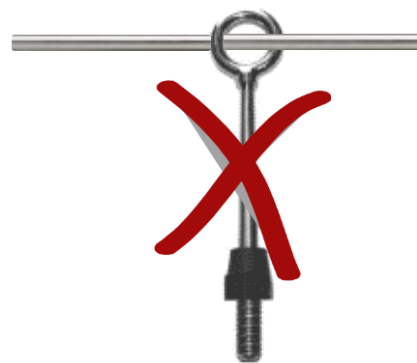

WRONG

DO NOT place an object into the eye of the eyebolt to tighten or un-tighten the locking hex nut, as this may damage the eyebolt.

MAINTENANCE – PERIODIC INSPECTIONS

All items of height safety equipment which are in regular use shall be subjected to periodic inspection and servicing. These regular scheduled inspections and servicing must be carried out by a competent height safety installer.

FIXED LADDERLINK: LADDER SUPPORT BRACKET

ALL LADDERLINKS MUST BE INSPECTED EVERY 12 MONTHS, INSPECTIONS NEED TO BE CARRIED OUT BY A COMPETENT HEIGHT SAFETY INSTALLER.

Procedures to be followed at inspection time:

- Visually inspect ladder support brackets for any signs of deterioration or the protective coating being removed. *(Note: LadderLink is made from marine grade aluminium and therefore should not corrode).*
- Ensure LadderLink is firmly secured to the structure as per SafetyLink Installation Handbook. *(refer to [Installing LadderLink](#)).*

SAFETYLINK ANCHORAGES

ALL ANCHORAGES MUST BE INSPECTED EVERY TWELVE MONTHS, INSPECTIONS NEED TO BE CARRIED OUT BY A COMPETENT HEIGHT SAFETY INSTALLER.

Procedures to be followed at inspection time:

- Visually inspect anchors for signs of deterioration.
- The FrogLink/TileLink anchor point has two energy absorbing regions and two stabilising joints which hold the eyelet in place during use. If these energy absorbing regions are expanded this will indicate the anchor point has arrested a fall. Similarly, if the two stabilising joints have been broken this would also indicate the FrogLink/TileLink has arrested a fall and should be replaced.
- The eyebolt should remain straight, a bent eyebolt will indicate that the anchor point has arrested a fall *(The design features of the eyebolt includes the ability to bend like a fishing pole starting from the top and working its way to the bottom, enabling it to use up energy as the eyebolt bends whilst lessening the force on the person falling and the attachment point).*
- Visually inspect the components of the anchor for corrosion, superficial surface marking is permitted while deeper corrosion or pitting would require attention.
- Manually (by hand) check the eyebolt for rigidity and tightness, if the eyebolt can turn in the anticlockwise direction it will require attention.
- Visually inspect the rubber hat washer and waterproofing components to ensure it has remained sealed.
- Visually inspect the attachment component of the anchorage where practically possible.
- Visually inspect the parent structure for modifications or deterioration which might lead to loss of anchorage strength.
- For Concrete Installation Only: To comply with Australian Standards, each Concretelink must be tested after installation and at every recertification inspection. Ensure you wait the recommended curing time as specified by the chemical anchor instructions. The pull test can be done using a 16mm threaded eyebolt. Test consists of ultimate pull out force proof loading to 50% of design purpose of anchorage.
- A personal energy absorber or a fall-arrest device with a personal energy absorber must be used in conjunction with all SafetyLink Anchorages and Lifeline systems.

IN ADDITION TO SAFETYLINK PTY LTD EQUIPMENT, ALL ANCILLARY EQUIPMENT MUST BE INSPECTED IN ACCORDANCE WITH APPLICABLE REGULATORY REQUIREMENTS AND THE MANUFACTURER'S INSTRUCTIONS.



**FOR MAINTENANCE ADVICE AND SERVICES PLEASE CONTACT SAFETYLINK
ON +61 249 641068 OR 1300 789545 FOR YOUR NEAREST SAFETYLINK INSPECTION SERVICE
CENTRE OR EMAIL: info@safetylink.com**

WARRANTIES

EXTRACT: SafetyLink Pty Ltd STANDARD TERMS AND CONDITIONS

- 11.1 To the extent permitted by law all implied conditions, warranties and undertakings are expressly excluded.
- 11.2 Except as provided in this clause the Company shall not be liable for any loss or damage, whether direct or indirect (including consequential losses or damage) arising out of any breach of contract by the Company or any negligence of the Company, its employees or agents.
- 11.3 Should the Company be liable for a breach of a guarantee, condition or warranty implied by the Australian Consumer Law (not being a guarantee, condition or warranty implied by sections 51, 52 and 53 of that Law) then its liability for a breach of any such condition or warranty express or implied shall be limited, at its option, to any one or more of the following.
- A) in case of Goods
- (I) the replacement of the Goods or the supply of equivalent Goods.
 - (II) the repair of the goods,
 - (III) the payment of the cost of replacing the Goods or acquiring equivalent Goods.
 - (IV) The payment of the cost of having the Goods repaired.
- Provided that any such Goods are returned to the Company by the Purchaser at the Purchaser's expense.
- B) in the case of services
- (i) the supply of the services again,
 - (ii) the payment of the cost of having the services supplied again.
- 11.4 The Company will not be liable for the costs of recovery of the Goods from the field, loss of use of the Goods, loss of time, inconvenience, incidental or consequential loss or damage, nor for any other loss or damage other than as stated above, whether ordinary or exemplary, caused either directly or indirectly by use of the Goods.
- 11.5 The Company warrants that at the time of shipment, Products manufactured by it will be free from defects in material and workmanship. In the absence of a modified written warranty, the Company agrees to making good any such defects by repairing the same or at the Company's option by replacement, for a period of (1) one year from the date of shipment. This limited warranty applies provided that:
- (a) defects have arisen solely from faulty materials or workmanship;
 - (b) the Products have not received maltreatment, inattention or interference;
 - (c) **the Products have been installed in accordance with the Company's Installation Handbooks using only products supplied by the Company;**
 - (d) accessories used with the Products are manufactured by or approved by the Company;
 - (e) the Products are maintained in accordance with Australian Standard 1891.4 (section 9).
 - (f) you notify any claim under this warranty to SafetyLink in writing to the address below no later than 14 days after the event or occurrence concerning the product giving rise to the claim and you pay all costs related to your claim.
- This warranty does not apply to any defects or other malfunctions caused to the Goods by accident, neglect, vandalism, misuse, alteration, modification or unusual physical, environment or electrical stress.
- Please note that the benefits to the purchaser (as a consumer) given by this warranty are in addition to your other rights and remedies under the Australian Consumer Law. Our goods come with guarantees that cannot be excluded under the Australian Consumer Law. You are entitled to a replacement or refund for a major failure and compensation for any other reasonably foreseeable loss or damage. You are also entitled to have the goods repaired or replaced if the goods fail to be of acceptable quality and the failure does not amount to a major failure.
- 11.6 If any goods are not manufactured by the Company, the guarantee of the manufacturer thereof shall be accepted by the Purchaser as the only express warranty given in respect of the goods.
- 11.7 Except as provided in this clause 11, all express and implied warranties, guarantees and conditions under statute or general law as the merchantability, description, quality, suitability or fitness of the Products for any purpose or as to design, assembly, installation, materials or workmanship or otherwise are hereby expressly excluded (to the extent to which they may be excluded by law).

PLEASE SEE SAFETYLINK PTY LTD FULL STANDARD TERMS OF CONDITIONS OF SALE FOR FURTHER REFERENCE.



CONCRETELINK ANCHOR POINT

Product Code: CONCL001

All safety procedures must comply in accordance with the current safety code(s) of practice(s) for working at heights. Ensure safety at all times during and after installation by using an appropriate height safety system.

POSITIONING OF CONCRETELINK ANCHOR POINT

- The Concrete Anchor must be in a position easily and safely reached from a safe access point.
- Concrete anchor should not be positioned close to an edge, minimum distance 150mm.
- Minimum concrete thickness 150mm.

LOCATING THE STEEL IN THE CONCRETE

Use *Digital metal detector (Example: BOSCH DMO 10)* to locate the Reo bar in the concrete when positioning the Concrete Anchor. This ensures reo bars are avoided when drilling.

DRILLING THE HOLE

Drill a 28mm hole to a depth of 90mm.

PREPARING THE HOLE

The hole must be moisture and dust free. Remove dust using compressed air, small brush and vacuum cleaner.

INSTALLING THE CONCRETE INSERT

- Recommended chemical is Fischer FIS-V.
- Prior to anchor installation, refer to installation procedure for individual anchor product and check chemical is within expiry date.
- The injection cartridge is for use with a standard caulking gun.
- Partially used cartridges can be re-used by changing the mixing nozzle.
- The entire surface of the anchors embedded section must be within the concrete and shall use sufficient adhesive gel as specified in *Appendix 1*.

FITTING THE SAFETYLINK STAINLESS STEEL EYEBOLT

1. When screwing the M16 nut onto the stainless steel eyebolt make sure it is fully screwed up exposing 30mm of thread, then screw the eyebolt into the ConcreteLink.
2. Ensure the eyebolt is positioned in-line with the fall of the roof.

Use Loctite on the eyebolt thread to ensure that the unit cannot be tampered with (IMPORTANT NOTE: Before applying Loctite 243 use Loctite 7471 primer to activate the surface according to manufacturer's instructions).

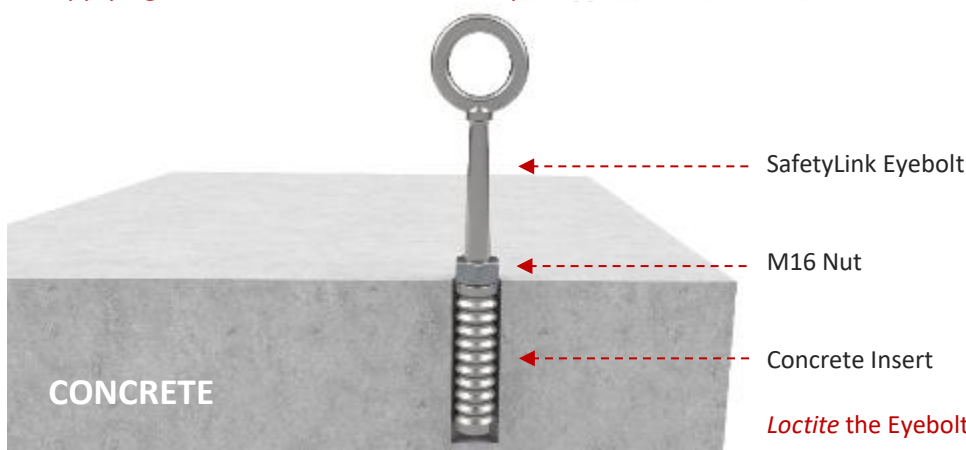

ConcreteLink
Installation Video



Testing for concrete mounted anchor. To comply with current Standards each Concrete unit must be tested after installation. Allow required curing time as specified in above table before testing. Test consists of pull out force to 50% of design load of anchorage. **Note: Drilled-in anchorages such as friction and glued-in anchorages shall be placed so that the shear load is at least twice the tension load. For collared eyebolts this translates to a pull at an angle not exceeding 20 degrees to the surface in which the bolt is installed.**

CONCRETELINK COLLARED EYEBOLT ANCHOR

Product Code: CONCL002

All safety procedures must comply in accordance with the current safety code(s) of practice(s) for working at heights. Ensure safety at all times during and after installation by using an appropriate height safety system.

POSITIONING OF CONCRETELINK ANCHOR POINT

- The Concrete Anchor must be in a position easily and safely reached from a safe access point.
- Concrete anchor should not be positioned close to an edge, minimum distance 150mm.
- Minimum concrete thickness 150mm.

LOCATING THE STEEL IN THE CONCRETE

Use *Digital metal detector (Example: BOSCH DMO 10)* to locate the Reo bar in the concrete when positioning the Concrete Anchor. This ensures reo bars are avoided when drilling.

DRILLING THE HOLE

Drill a 28mm hole to a depth of 90mm.

PREPARING THE HOLE

The hole must be moisture and dust free. Remove dust using compressed air, small brush and vacuum cleaner.

INSTALLING THE CONCRETE INSERT

- Recommended chemical is Fischer FIS-V.
- Prior to anchor installation, refer to installation procedure for individual anchor product and check chemical is within expiry date.
- The injection cartridge is for use with a standard caulking gun.
- Partially used cartridges can be re-used by changing the mixing nozzle.
- The entire surface of the anchors embedded section must be within the concrete and shall use sufficient adhesive gel as specified in *Appendix 1*.

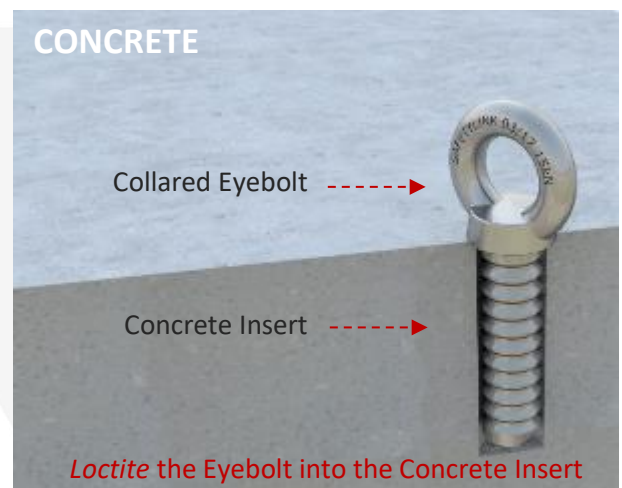

FITTING THE COLLARED EYEBOLT

- Screw the collared eyebolt into the Concretelink (coat threads with Loctite).
- Ensure the collared eyebolt is positioned in-line with the fall of the roof.

Use *Loctite* on the eyebolt thread to ensure that the unit cannot be tampered with (**IMPORTANT NOTE: Before applying Loctite 243 use Loctite 7471 primer to activate the surface according to manufacturer's instructions**).

Testing for concrete mounted anchor. To comply with current Standards each Concrete unit must be tested after installation. Allow required curing time as specified in above table before testing. Test consists of pull out force to 50% of design load of anchorage. **Note: Drilled-in anchorages such as friction and glued-in anchorages shall be placed so that the shear load is at least twice the tension load. For collared eyebolts this translates to a pull at an angle not exceeding 20 degrees to the surface in which the bolt is installed.**

CONCRETELINK ONE PIECE EYEBOLT ANCHOR

Product Code: CONCL005

All safety procedures must comply in accordance with the current safety code(s) of practice(s) for working at heights. Ensure safety at all times during and after installation by using an appropriate height safety system.

POSITIONING OF CONCRETELINK ANCHOR POINT

- The Concrete Anchor must be in a position easily and safely reached from a safe access point.
- Concrete anchor should not be positioned close to an edge, minimum distance 150mm.
- Minimum concrete thickness 150mm.

LOCATING THE STEEL IN THE CONCRETE

Use *Digital metal detector (Example: BOSCH DMO 10)* to locate the Reo bar in the concrete when positioning the Concrete Anchor. This ensures reo bars are avoided when drilling.

DRILLING THE HOLE

Drill a 18mm hole to a depth of 90mm.

PREPARING THE HOLE

The hole must be moisture and dust free. Remove dust using compressed air, small brush and vacuum cleaner.

INSTALLING

- Recommended chemical is Fischer FIS-V.
- Prior to anchor installation, refer to installation procedure for individual anchor product and check chemical is within expiry date.
- The injection cartridge is for use with a standard caulking gun.
- Partially used cartridges can be re-used by changing the mixing nozzle.
- The entire surface of the anchors embedded section must be within the concrete and shall use sufficient adhesive gel as specified in *Appendix 1*.

FITTING THE CONCRETELINK ONE PIECE UNIT

Ensure the collared eyebolt is positioned in-line with the fall of the roof.

One Piece ConcreteLink

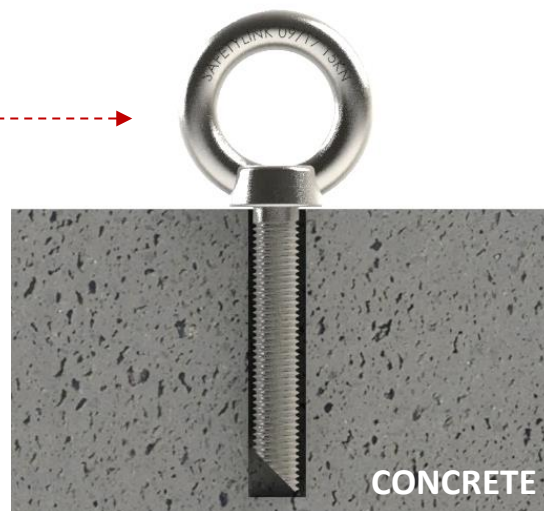

Testing for concrete mounted anchor. To comply with current Standards each Concrete unit must be tested after installation. Allow required curing time as specified in above table before testing. Test consists of pull out force to 50% of design load of anchorage. **Note: Drilled-in anchorages such as friction and glued-in anchorages shall be placed so that the shear load is at least twice the tension load. For collared eyebolts this translates to a pull at an angle not exceeding 20 degrees to the surface in which the bolt is installed.**

WINDOWLINK ANCHOR POINT

Product Code: WINDW001

WINDOWLINK COMES AS A SINGLE READY TO INSTALL UNIT

All safety procedures must comply in accordance with the current safety code(s) of practice(s) for working at heights. Ensure safety at all times during and after installation by using an appropriate height safety system.



POSITIONING OF WINDOWLINK ANCHOR POINT

- The Concrete Anchor must be in a position easily and safely reached from a safe access point.
- Concrete anchor should not be positioned close to an edge, minimum distance 150mm.
- Minimum concrete thickness 150mm.

LOCATING THE STEEL IN THE CONCRETE

Use *Digital metal detector (Example: BOSCH DMO 10)* to locate the Reo bar in the concrete when positioning the Concrete Anchor. This ensures reo bars are avoided when drilling.

DRILLING THE HOLE

1. Two holes must be drilled, drill first hole using a 55mm hole saw drill to a depth of 20mm.
2. Then drill second hole with a 28mm width and a depth of 122mm.

PREPARING THE HOLE

1. Using a small chisel remove the excess concrete to fit the shape of the WindowLink.
2. The hole must be moisture and dust free. Remove dust using compressed air, small brush and vacuum cleaner.

INSTALLING CHEMICAL ANCHOR

- Recommended chemical is Fischer FIS-V.
- Prior to anchor installation, refer to installation procedure for individual anchor product and check chemical is within expiry date.
- The injection cartridge is for use with a standard caulking gun.
- Partially used cartridges can be re-used by changing the mixing nozzle.
- The entire surface of the anchors embedded section must be within the concrete and shall use sufficient adhesive gel as specified in *Appendix 1*.

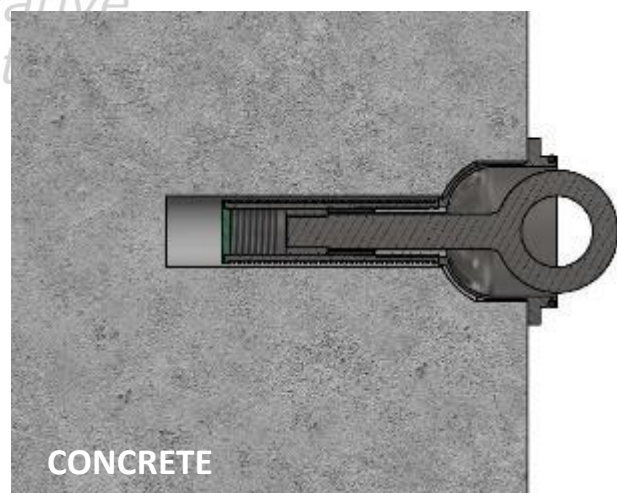
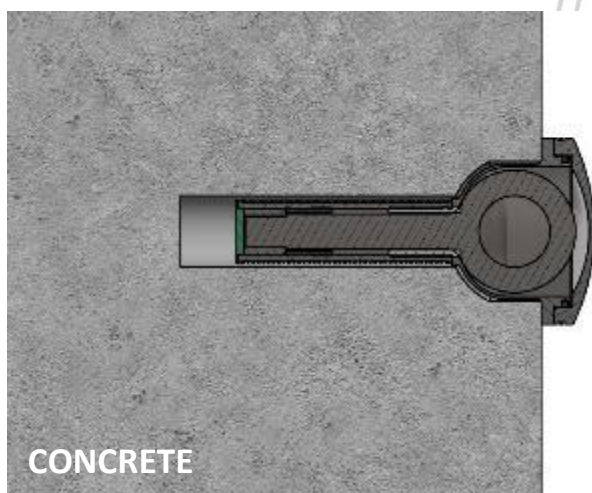

Testing for concrete mounted anchor. To comply with current Standards each Concrete unit must be tested after installation. Allow required curing time as specified in above table before testing. Test consists of pull out force to 50% of design load of anchorage. **Note: Drilled-in anchorages such as friction and glued-in anchorages shall be placed so that the shear load is at least twice the tension load. For collared eyebolts this translates to a pull at an angle not exceeding 20 degrees to the surface in which the bolt is installed.**

SWIVELINK ANCHOR POINT

With Nut - Product Code: SWIVL001
Without Nut - Product Code: SWIVL002

SWIVELINK COMES AS A SINGLE READY TO INSTALL UNIT

All safety procedures must comply in accordance with the current safety code(s) of practice(s) for working at heights. Ensure safety at all times during and after installation by using an appropriate height safety system.

POSITIONING OF SWIVELINK ANCHOR POINT

- The Concrete Anchor must be in a position easily and safely reached from a safe access point.
- Concrete anchor should not be positioned close to an edge, minimum distance 150mm.
- Minimum concrete thickness 150mm.

LOCATING THE STEEL IN THE CONCRETE

Use *Digital metal detector (Example: BOSCH DMO 10)* to locate the Reo bar in the concrete when positioning the Concrete Anchor. This ensures reo bars are avoided when drilling.

DRILLING THE HOLE

Drill a 28mm hole to a depth of 90mm.

PREPARING THE HOLE

The hole must be moisture and dust free.
Remove the dust using compressed air.

INSTALLING THE CONCRETE INSERT

- Recommended chemical is Fischer FIS-V.
- Prior to anchor installation, refer to installation procedure for individual anchor product and check chemical is within expiry date.
- The injection cartridge is for use with a standard caulking gun.
- Partially used cartridges can be re-used by changing the mixing nozzle.
- The entire surface of the anchors embedded section must be within the concrete and shall use sufficient adhesive gel as specified in *Appendix 1*.

Testing for concrete mounted anchor. To comply with current Standards each Concrete unit must be tested after installation. Allow required curing time as specified in above table before testing. Test consists of pull out force to 50% of design load of anchorage. **Note: Drilled-in anchorages such as friction and glued-in anchorages shall be placed so that the shear load is at least twice the tension load. For collared eyebolts this translates to a pull at an angle not exceeding 20 degrees to the surface in which the bolt is installed.**

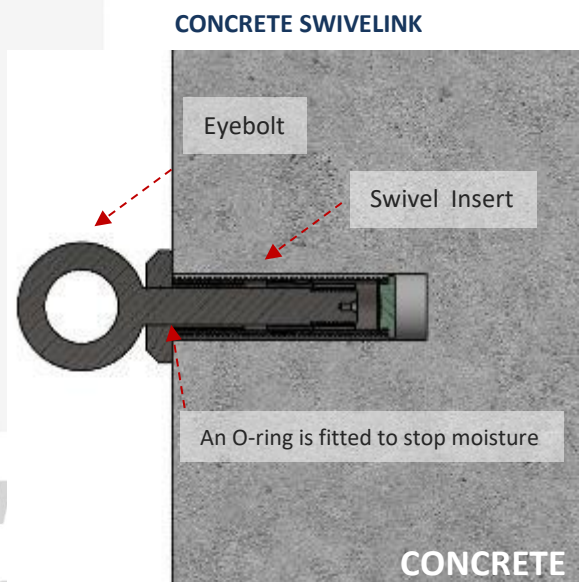

STEEL MOUNTED SWIVELINK



SPACERLINK ANCHOR POINT

Product Code: SPACE001

All safety procedures must comply in accordance with the current safety code(s) of practice(s) for working at heights. Ensure safety at all times during and after installation by using an appropriate height safety system.

POSITIONING OF SPACERLINK ANCHOR POINT

- The Concrete Anchor must be in a position easily and safely reached from a safe access point.
- Concrete anchor should not be positioned close to an edge, minimum distance 150mm.
- Minimum concrete thickness 150mm.

LOCATING THE STEEL IN THE CONCRETE

Use Digital metal detector (Example: BOSCH DMO 10) to locate the Reo bar in the concrete when positioning the Concrete Anchor. This ensures reo bars are avoided when drilling.

PREPARATION TIPS

Determine the distance that the anchor will be threaded through. Cut the threaded rod if necessary. Hammer Drill – stop hammering action on last section of concrete to prevent blowing out section.

DRILLING THE HOLE

Drill a pilot hole through the concrete.

Then drill a 25mm hole from either side of the wall, avoid damaging the wall.

FITTING THE EYEBOLT

1. When screwing the M16 Eyebolt onto the Allthread Rod make sure it is fully screwed up exposing end of thread.
2. Use *Loctite* on the Eyebolt and Allthread Rod to ensure that the unit cannot be tampered with (**IMPORTANT NOTE: Before applying Loctite 243 use Loctite 7471 primer to activate the surface according to manufacturer's instructions**).
3. Assemble the 70mm washer with foam onto the rod then push the unit through the wall and fit the 70mm washer and M16 nut.
4. Ensure the Eyebolt is positioned in-line with the fall of the roof.

Threads need to have a minimum of **six full 360° turns** into the ultimate thread.

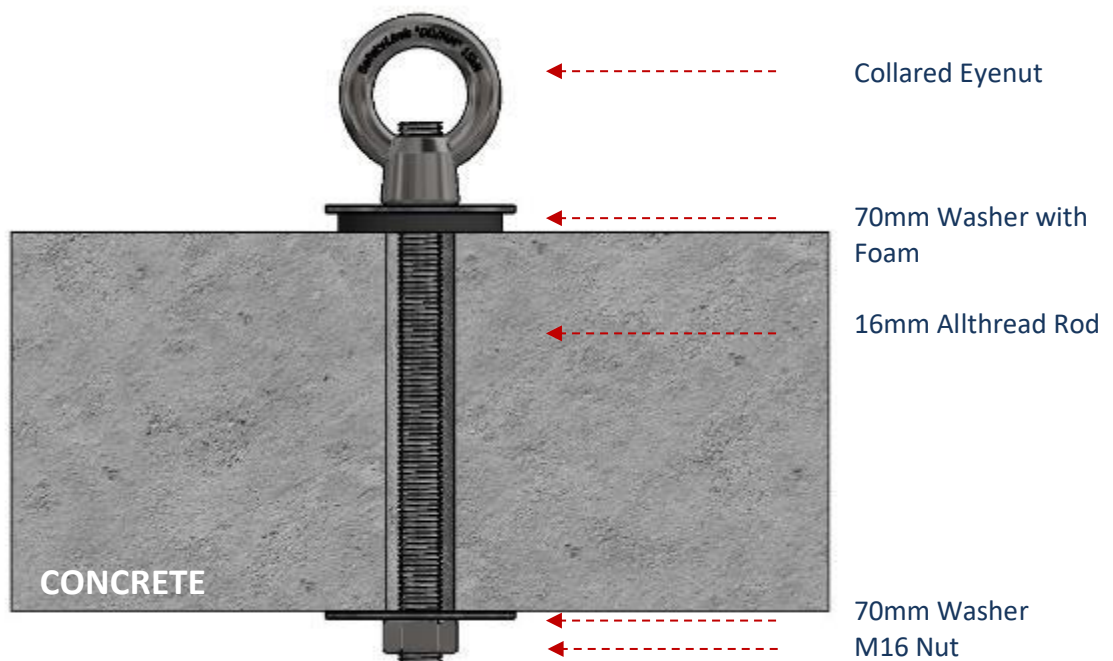

APPENDIX 1 – CONCRETE INJECTION MORTAR

POSITIONING OF CONCRETE ANCHOR - The Concrete Anchor must be in a position easily and safely reached from a safe access point. Concrete anchor should not be positioned close to an edge, minimum distance 150mm. Minimum concrete thickness 150mm.



LOCATING THE REINFORCING STEEL BAR (REO BAR) IN THE CONCRETE - Use *Digital metal detector (Example: BOSCH DMO 10)* to locate the Reo bar in the concrete when positioning the Concrete Anchor. This ensures reo bars are avoided when drilling.

DRILLING THE HOLE - Drill a hole to a depth and width as suggested in below table.

PREPARING THE HOLE - The hole must be moisture and dust free. Remove dust using compressed air, small brush, and vacuum cleaner.

INSTALLING THE CONCRETE ANCHOR - Recommended chemical is **Fischer FIS-V**.

- Prior to anchor installation, refer to installation procedure for individual anchor product and check chemical is within expiry date.
- The injection cartridge is for use with a standard caulking gun.
- Partially used cartridges can be re-used by changing the mixing nozzle.
- The entire surface of the anchors embedded section must be within the concrete and shall use sufficient adhesive mortar as specified in the table below.

PRODUCT CODE: CON-CHEM-FISV.300			
Product Code	Description	Qty	
CON-CHEM-FISV.300.01	Injection Mortar FIS V Cartridge 300ml	1	
CON-CHEM-FISMR	Static Mixer FIS MR	2	

FIS V 300T: INJECTION MORTAR					
APPLICATION	ANCHOR DIAMETER(mm)	DRILL HOLE DIAMETER(mm)	DRILL HOLE DEPTH(mm)	MORTAR/ FIXING(ml)	NO# OF FIXING/ CARTRIDGE
DonutLink FrogLine	16	18	95	15	20
Concrete Insert	24	28	90	40	7.5
One Piece Eyebolt	16	18	90	15	20
WindowLink	53&25	55&28	20&122	60	5
SwiveLink	24	28	90	40	7.5
M12x160 Anchor Rod	12	14	115	10	30
M16x160 Anchor Rod	16	18	115	15	20
X-Rail	12	14	95	10	30

CURING TIME FIS V			
Cartridge Temperature (mortar)	Gelling Time	Temperature at anchoring base	Curing Time
		- 5°C - ± 0°C	24 hours
+ 0°C - + 5°C	13 minutes	± 0°C - + 5°C	3 hours
+ 5°C - + 10°C	9 minutes	+ 5°C - + 10°C	90 minutes
+ 10°C - + 20°C	5 minutes	+ 10°C - + 20°C	60 minutes
+ 20°C - + 30°C	4 minutes	+ 20°C - + 30°C	45 minutes
+ 30°C - + 40°C	2 minutes	+ 30°C - + 40°C	35 minutes

The above times apply from the moment of contact between resin and hardener in the static mixer.

For installation, the cartridge temperature must be at least +5°C. For longer installation times, ie when interruptions occur in work, the mixer should be replaced.

Testing for concrete mounted anchor.

To comply with current Standards each Concrete unit must be tested after installation. Allow required curing time as specified in above table before testing. Test consists of pull out force to 50% of design load of anchorage.

Note: Drilled-in anchorages such as friction and glued-in anchorages shall be placed so that the shear load is at least twice the tension load. For collared eyebolts this translates to a pull at an angle not exceeding 20 degrees to the surface in which the bolt is installed.

APPENDIX – Diagram 2 – Anchor Positioning Layout

THIS IS A GUIDE ONLY

All working at heights safety procedures must be complied with when installing SafetyLink anchor points. For more information refer to your state or territories current legislation, regulations, policies and codes of practices.

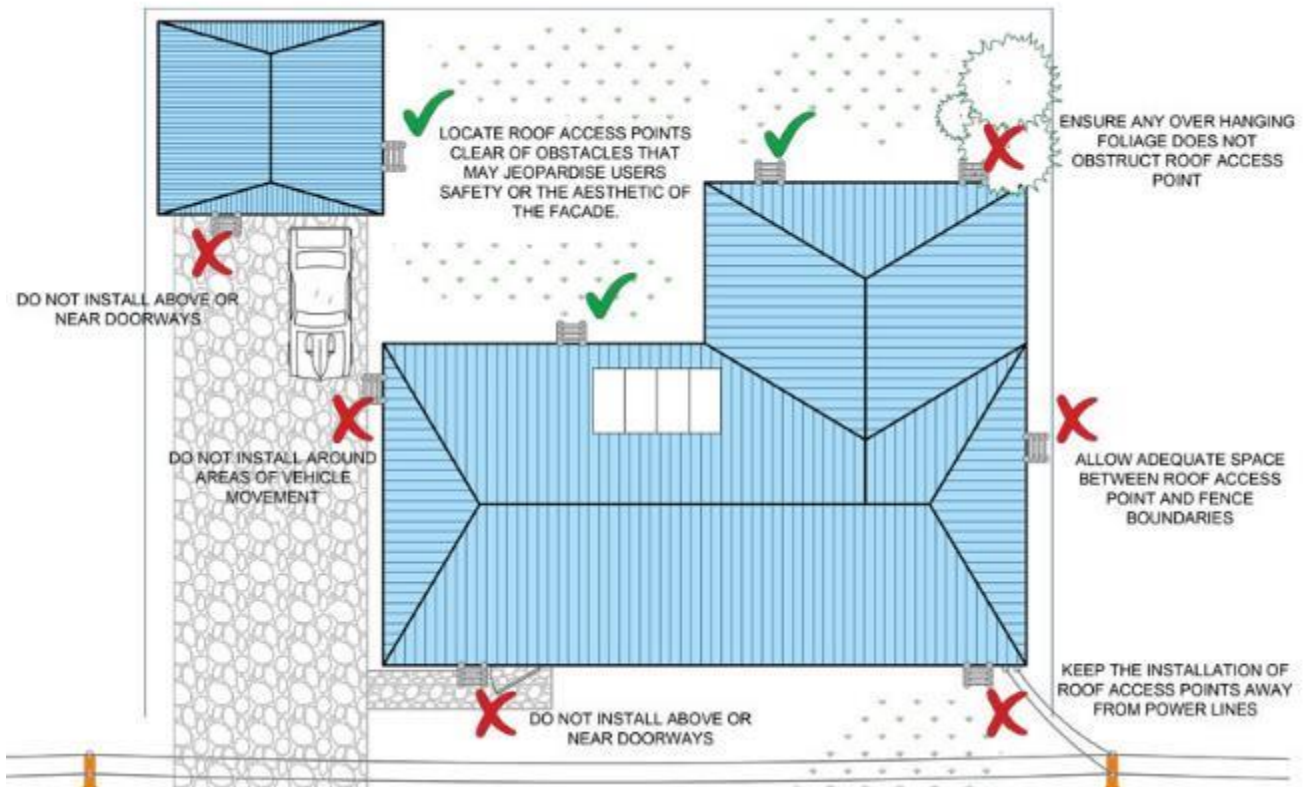

- ⚠ IF ANY DOUBT EXISTS WITH THE STRENGTH OF THE STRUCTURE OR ROOF SHEETS AN ENGINEER SHOULD MAKE THE ASSESSMENT.
- ⚠ DURING INSTALLATION YOU MUST BE SAFE AT ALL TIMES.
- ⚠ INSTALLATION MUST BE CARRIED OUT BY, OR UNDER THE SUPERVISION OF A COMPETENT HEIGHT SAFETY INSTALLER.

ACCESS, LAYOUT AND USE OF A SAFETYLINK ANCHOR SYSTEM

SafetyLink anchor points are positioned by calculating the pendulum effect, this limits the likelihood of a fall past the edge of the roof space. The pendulum effect still applies to a flat roof.

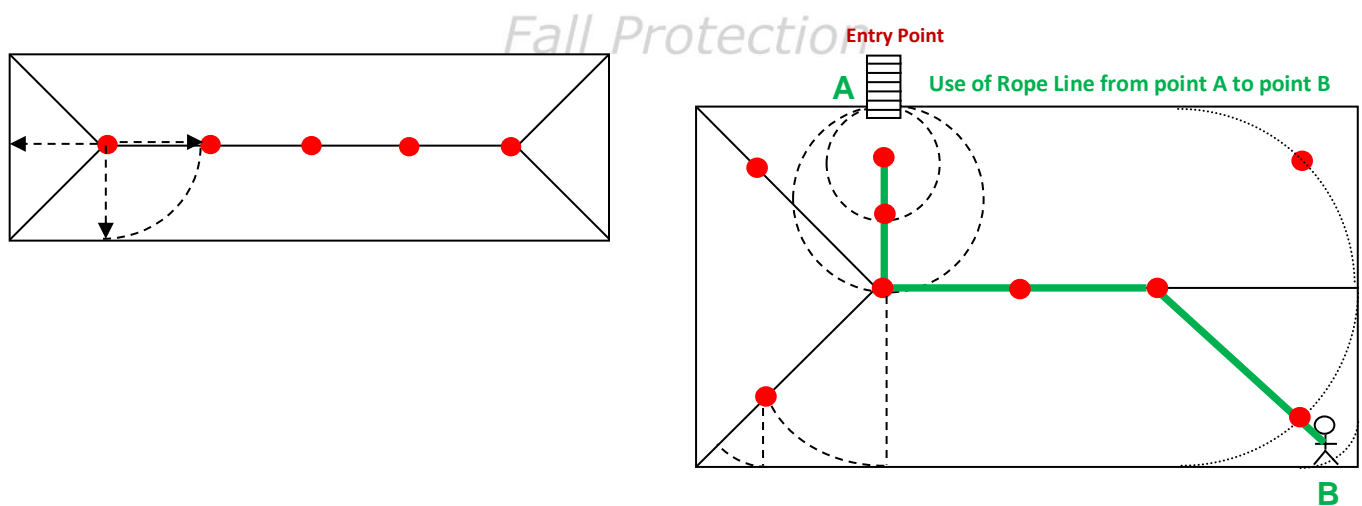

SPACING MUST BE NO GREATER THAN THE RAFTER LENGTH, PLEASE CONTACT YOUR DISTRIBUTOR IF YOU ARE UNSURE.

SAFETYLINK HEIGHT SAFETY SYSTEMS MUST ONLY BE INSTALLED AS PER OUR INSTALLATION GUIDES, TO STRUCTURES AS SPECIFIED IN THE INSTALLATION MANUAL FOR EACH PRODUCT. SHOULD ANY DOUBT EXIST IN REGARD TO THE STRUCTURES INTEGRITY AN ENGINEER SHOULD BE CONSULTED.

EXPERT FALL PROTECTION PLANNING

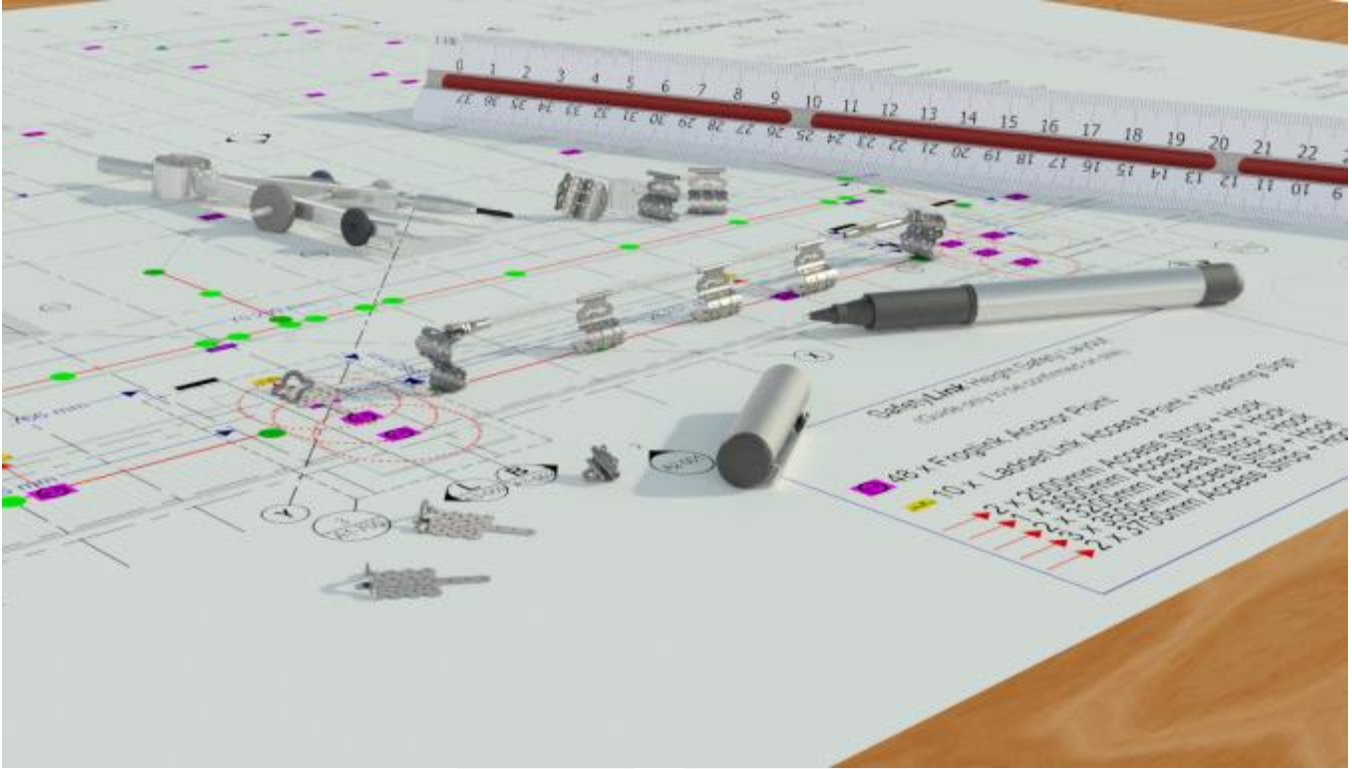

SafetyLink's design and planning team are here to help work out the positioning of your fall protection system, ensuring all areas of your roof are accessed safely.

Things to consider when planning your roof layout:

- Are all areas of your roof protected, allowing complete access when working at heights?
- Are you protected from the ground up, allowing complete access to your roof?
- Detailed comprehensive documentation provided e.g. installation guides, testing results, product sheets should be provided.
- SafetyLink can also provide you with a qualified and reputable installer of SafetyLink products.

Contact our design team at info@safetylink.com and we can plan your fall arrest system for you.

© 2018, SafetyLink Pty Ltd, Australia.

Patents: SafetyLink Pty Ltd has a multitude of patents, patents pending, design applications, trademarks and copyrighted documents both lodged and issued. Should you wish to know the progress of our intellectual property on a specific product please email us on ip@safetylink.com and quote the product code.



SafetyLink®

*Innovative
Fall Protection*

IN CASE OF ACCIDENT

- ⚠️ **A FALL RESCUE PLAN AND SAFE WORK STATEMENT MUST BE DEVELOPED PRIOR TO USING SAFETYLINK SYSTEMS AND EQUIPMENT.**
- ⚠️ **PERSONS WORKING AT HEIGHTS SHOULD NOT WORK ALONE.**

It is critical that before using any SafetyLink Systems a fall rescue plan is in place for any persons suspended mid-air following a fall. Serious injury or death can occur in a matter of minutes, particularly if a person's movement or breathing is restricted or loss of consciousness has occurred. In accordance with your fall rescue plan and appropriate first aid procedures it is essential to remove the person from the suspended position as quickly as possible.

In accordance with AS/NZS 1891.4:2009 clause 9.5

EQUIPMENT WHICH HAS ARRESTED A FALL OR SHOWS A DEFECT

Any piece of equipment including both personal and permanently installed items, which has been used to arrest a fall or which shows any defect during operator or periodic inspection shall be withdrawn from service immediately and a replacement obtained if necessary. A label indicating the condition or defect should be attached to the equipment, and it should be examined by a competent height safety installer who will decide whether the equipment is to be destroyed or repaired if necessary and returned to service. In the latter case, details of any repair shall be documented, and a copy given to the operator.



DISTRIBUTOR:

SafetyLink Pty Ltd | ABN 83 081 777 371
Phone: 1300 789 545 or +61 2 4964 1068
info@safetylink.com | www.safetylink.com